

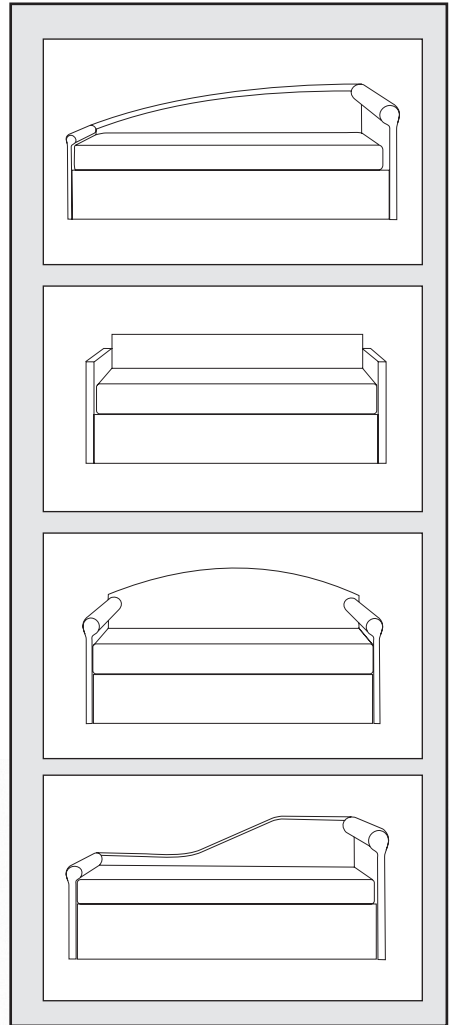

Listino Prezzi
COLLECTION SOLUTION

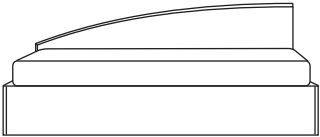
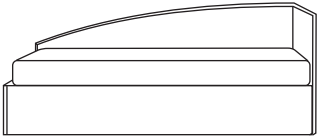
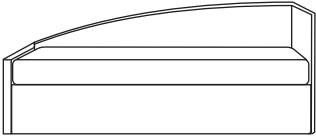
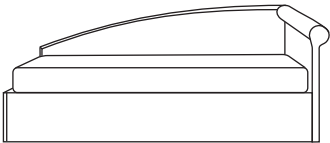
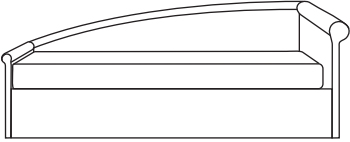
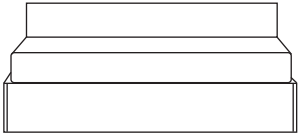
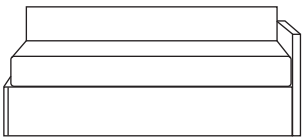

Compreso: seconda rete estraibile

Letto Mod. SOLUTION 2200	Misure	Tessuto Cat. 1	Tessuto Cat. 2
2200 cod. 01 	L 198 P 89 H 83		
2200 cod. 02 	L 198 P 89 H 83		
2200 cod. 03 	L 198 P 89 H 83		
2200 cod. 04 	L 201 P 89 H 83		
2200 cod. 05 	L 206 P 89 H 83		
2200 cod. 06 	L 198 P 89 H 83		
2200 cod. 07 	L 198 P 89 H 83		

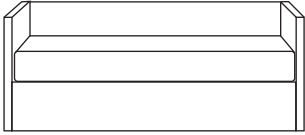
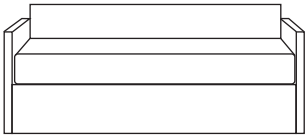
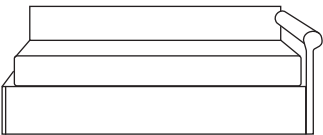
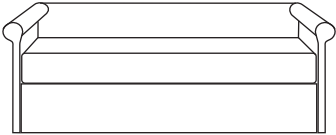
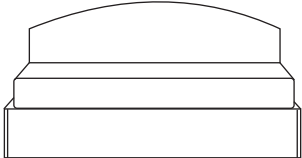
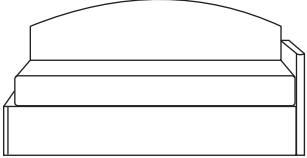
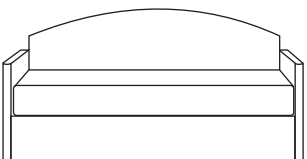

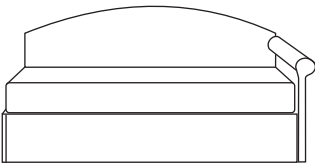
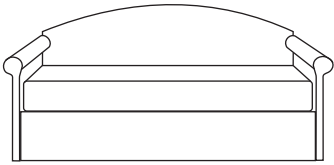
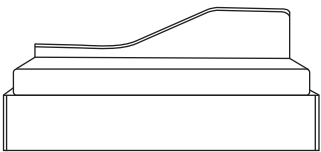
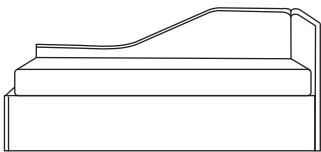
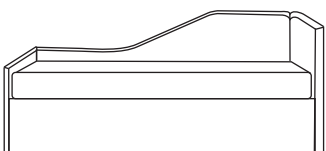
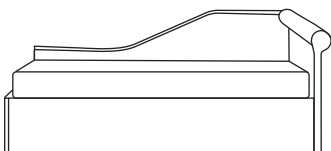
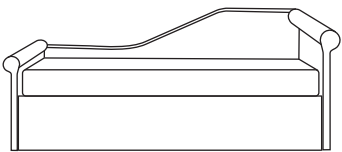
Letto Mod. SOLUTION 2200	Misure	Tessuto Cat. 1	Tessuto Cat. 2
2200 cod. 08 	L 198 P 89 H 83		
2200 cod. 09 	L 198 P 89 H 83		
2200 cod. 10 	L 201 P 89 H 83		
2200 cod. 11 	L 206 P 89 H 83		
2200 cod. 12 	L 198 P 89 H 93		
2200 cod. 13 	L 198 P 89 H 93		
2200 cod. 14 	L 198 P 89 H 93		



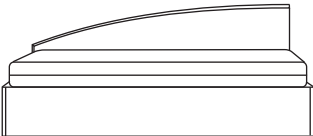
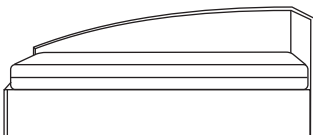
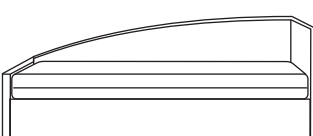
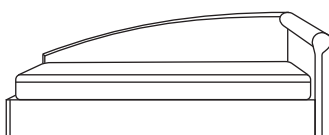
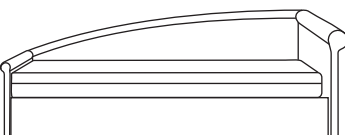
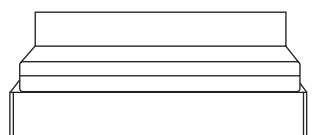
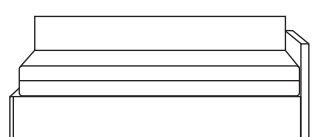

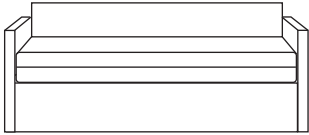
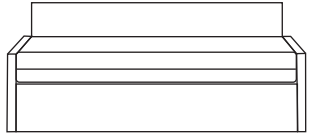
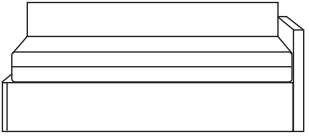
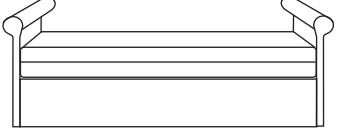
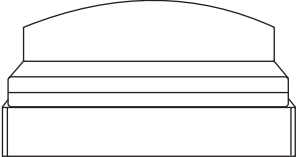
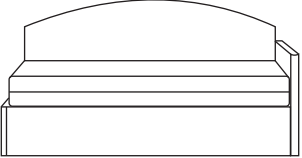
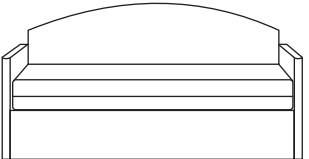
Letto Mod. SOLUTION 2200	Misure	Tessuto Cat. 1	Tessuto Cat. 2
2200 cod. 15 	L 201 P 89 H 93		
2200 cod. 16 	L 206 P 89 H 93		
2200 cod. 17 	L 198 P 89 H 83		
2200 cod. 18 	L 198 P 89 H 83		
2200 cod. 19 	L 198 P 89 H 83		
2200 cod. 20 	L 201 P 89 H 83		
2200 cod. 21 	L 206 P 89 H 93		

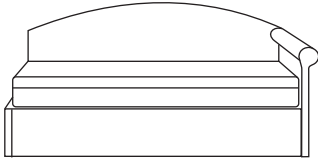
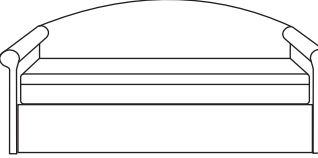
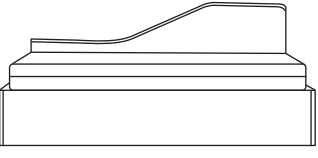
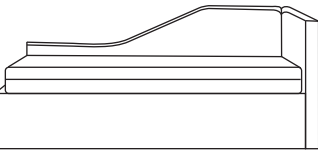
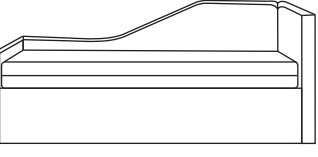

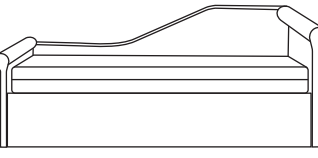

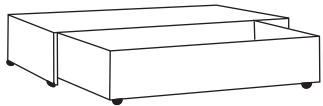
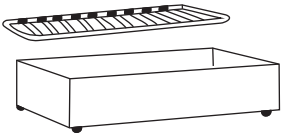
Compreso: materasso divisibile, seconda rete + contenitore

Letto Mod. SOLUTION 6000	Misure	Tessuto Cat. 1	Tessuto Cat. 2
<p>6000 cod. A</p> 	<p>L 204 P 95 H 83</p>		
<p>6000 cod. B</p> 	<p>L 204 P 95 H 83</p>		
<p>6000 cod. C</p> 	<p>L 204 P 95 H 83</p>		
<p>6000 cod. D</p> 	<p>L 207 P 95 H 83</p>		
<p>6000 cod. E</p> 	<p>L 210 P 95 H 83</p>		
<p>6000 cod. F</p> 	<p>L 204 P 95 H 83</p>		
<p>6000 cod. G</p> 	<p>L 204 P 95 H 83</p>		

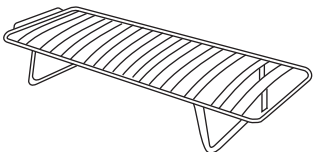
Letto Mod. SOLUTION 6000	Misure	Tessuto Cat. 1	Tessuto Cat. 2
6000 cod. H 	L 204 P 95 H 83		
6000 cod. I 	L 204 P 95 H 83		
6000 cod. J 	L 204 P 95 H 83		
6000 cod. K 	L 210 P 95 H 93		
6000 cod. L 	L 204 P 95 H 93		
6000 cod. M 	L 204 P 95 H 93		
6000 cod. N 	L 204 P 95 H 93		

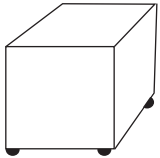
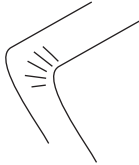
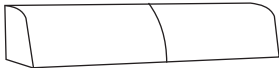
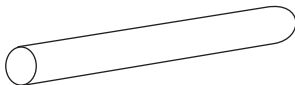
Letto Mod. SOLUTION 6000	Misure	Tessuto Cat. 1	Tessuto Cat. 2
6000 cod. O 	L 207 P 95 H 93		
6000 cod. P 	L 210 P 95 H 93		
6000 cod. Q 	L 204 P 95 H 83		
6000 cod. R 	L 204 P 95 H 83		
6000 cod. S 	L 204 P 95 H 83		
6000 cod. T 	L 207 P 95 H 83		
6000 cod. U 	L 210 P 95 H 93		

ACCESSORI	€
<p>CASSETTONE BOX</p>  <p>H 26 P 82 L 190</p>	
<p>RETE UTILIZZABILE PER CASSETTONE BOX</p>  <p>H 4 P 82/85 L 190</p> <p>RETE UTILIZZABILE SOLO PER CASSETTONE BOX PER AVERE LETTO MATRIMONIALE O DUE LETTI SINGOLI</p>	
<p>MATERASSO DIVISIBILE A DUE ALTEZZE UTILIZZABILE SOLO SU CASSETTONE BOX PER AVERE LETTO MATRIMONIALE OPPURE DUE LETTI SINGOLI</p>  <p>H 18 P 90 L 195</p>	
<p>MATERASSO 190X80 H 18 IN GOMMA AD ALTA TENSITA'.</p>  <p>GOMMA</p>	
<p>MATERASSO 190X80 H18 A MOLLE</p>  <p>MOLLE</p>	
<p>RETE ESTRAIBILE PER SECONDO LETTO CM 190X80</p>  <p>H 32 P 80 L 190</p>	

ACCESSORI	€
<p>POUFF</p>  <p>H 45 P 89 L 89</p>	
<p>COPRIMATERASSO CON STESSO TESSUTO</p> 	
<p>CUSCINI SCHIENALE PER DIVANO A COPPIA</p>  <p>H 33 P 28 L 190</p>	
<p>RULLO IN GOMMA</p>  <p>H 15 P 15 L 190</p>	
<p>RULLO IN GOMMA</p>  <p>H 15 P 15 L 90</p>	
<p>RULLO IN GOMMA</p>  <p>H 15 P 15 L 53</p>	
<p>CUSCINO DECORO CUORE</p>  <p>H 40 P 25 L 50</p>	

FERRAMENTA SOLUTION 6000

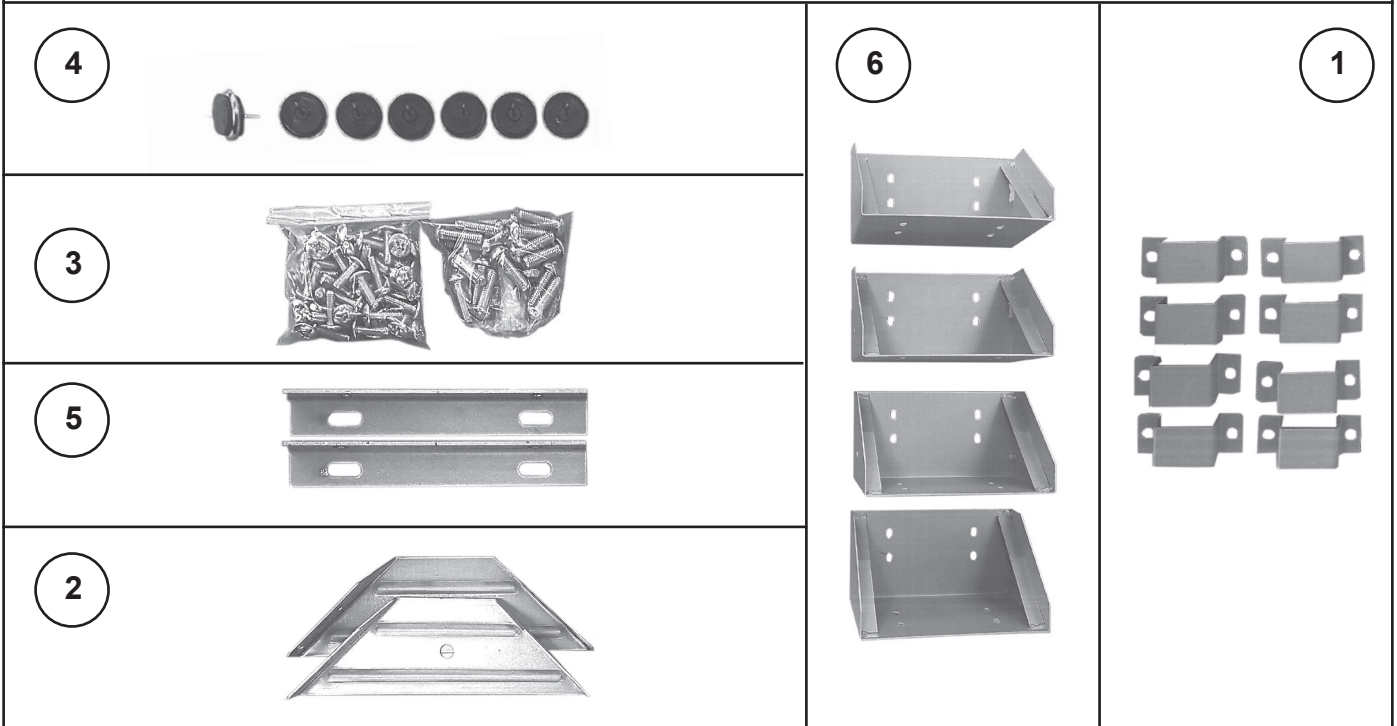

DISTINTA FERRAMENTA

N° 4 ANGOLARI 10X10XH20
 N° 2 ANGOLARI
 N° 2 LINGUETTE





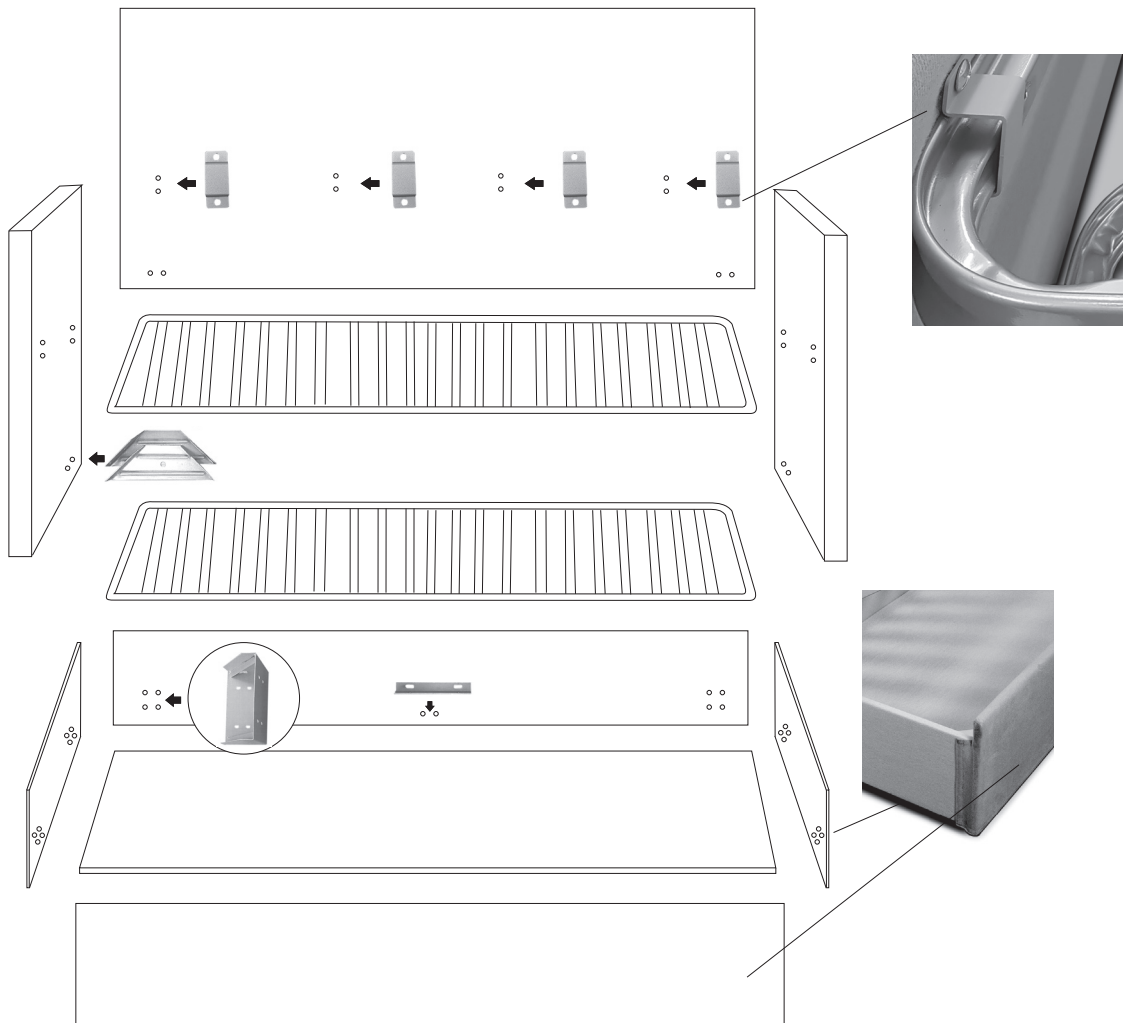

8 FORI
 4 FORI
 4 FORI

N° 52 BULLONI TBL DA
 N° 16 BULLONI DA
 N° 8 STAFFE
 N° 7 PIEDINI

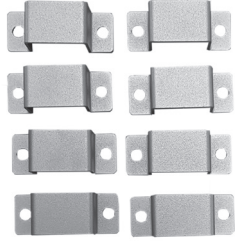
6 mm
 8 mm
 2 FORI



FERRAMENTA SOLUTION 2200

2		1	
4		5	
7		6	
3			

DISTINTA FERRAMENTA

N° 2 ANGOLARI	4 FORI
N° 2 LINGUETTE	4 FORI
N° 26 BULLONI TBL DA	6 mm
N° 16 BULLONI DA	8 mm

N° 8 STAFFE

N° 7 PIEDINI
N° 4 RUOTE
N° 2 MOLLE

